

#### Material

Housing: PA66, UL94V-0  
 Pin header: Brass, Tin plated  
 Clamp: Brass, Ni plated  
 Screw: M2.5, steel Zinc plated



#### Electrical

Rated voltage: 300V  
 Rated current: 15A  
 Contact Resistance: 20 mΩ  
 Insulation resistance: 500MΩ/DC500V  
 Withstand voltage: AC2000V / 1 min  
 Wire Range: 30~14AWG 2.5mm<sup>2</sup>

#### Mechanical

Temp. Range: -40 °C ~ +105 °C  
 Strip length: 6~7mm  
 Torque: 0.4Nm (3.5Lb.in)

#### Order Information

RE - C - 128A2 - 5.08 - XXP - 4 S 00

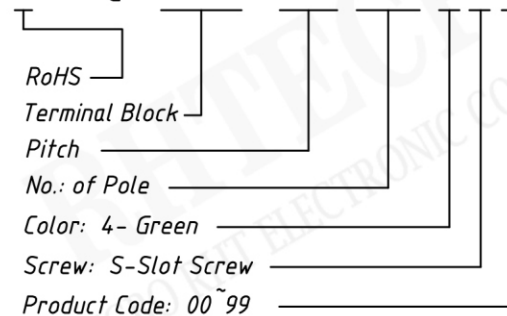

NINGBO RHT ELECTRONIC CO.,LTD

UNITS:mm

SHEET SIZE:A4

SCALE: ---

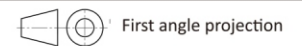

> 0~3

> 3~18

> 18~50

> 50~120

± 0.12

± 0.15

± 0.3

± 0.5

TERMINAL BLOCK

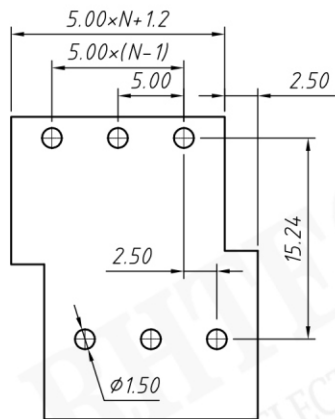

PCB LAYOUT

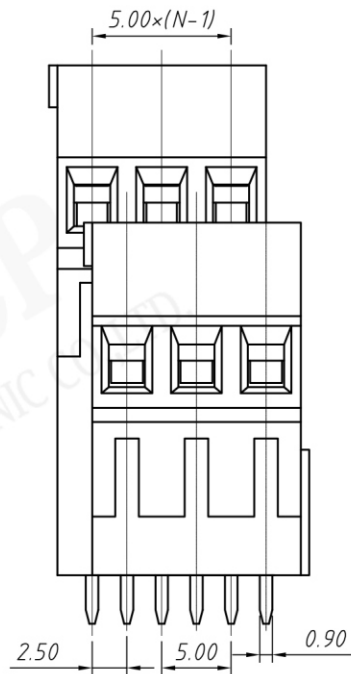
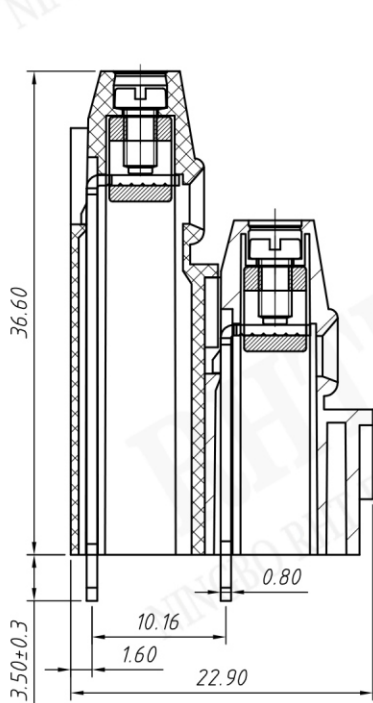
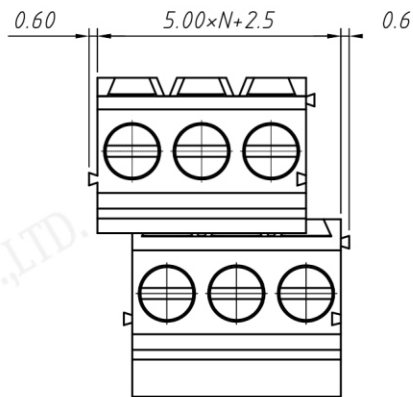

**Material**

Housing: PA66, UL94V-0  
 Pin header: Brass, Tin plated  
 Clamp: Brass, Ni plated  
 Screw: M2.5, steel Zinc plated



**Electrical**

Rated voltage: 300V  
 Rated current: 15A  
 Contact Resistance: 20 mΩ  
 Insulation resistance: 500MΩ/DC500V  
 Withstand voltage: AC2000V / 1 min  
 Wire Range: 30~14AWG 2.5mm<sup>2</sup>

**Mechanical**

Temp. Range: -40 °C ~ +105 °C  
 Strip length: 6~7mm  
 Torque: 0.4Nm (3.5Lb.in)

**Order Information**

RE - C - 128A2 - 5.00 - XXP - 4 S 00

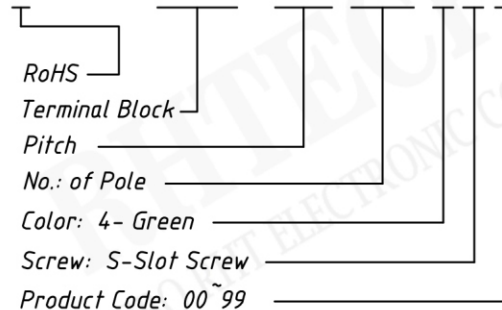

NINGBO RHT ELECTRONIC CO.,LTD

UNITS:mm

SHEET SIZE:A4

SCALE: ---



First angle projection

> 0~3

> 3~18

> 18~50

> 50~120

± 0.12

± 0.15

± 0.3

± 0.5

TERMINAL BLOCK