

Material:

Housing: 30% Glass filled PPS UL 94V-0

Contacts: Beryllium copper or Phosphor Bronze

Plating: Gold 1.25u" over 50u" nickel

Electrical Characteristics:

Current Rating: 3.0 AMP

Insulator Resistance: 1000MΩ min. at DC 100V

Contact Resistance: 10mΩ max.

Operating Temperature: -40°C ~ +105°C

Order Information:

RE - C - 209 - 1.9 - 1 - XX - S - Y

IC Socket

Plastic height:

1.9mm, 3.0mm, 4.2mm, 7.0mm

Row: 1-Single layer

2-Double layer

XX-No. of 02 ~ 80pin

Type: S-Straight Pin

R-Right Angle Pin T-SMT Pin

Y-Imported Beryllium copper

Z-Domestic Phosphor Bronze

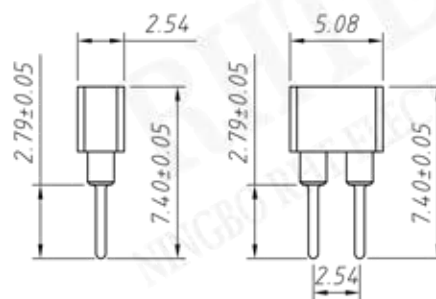
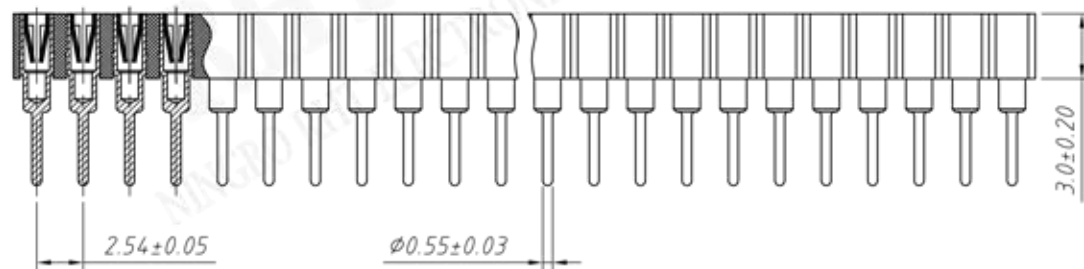
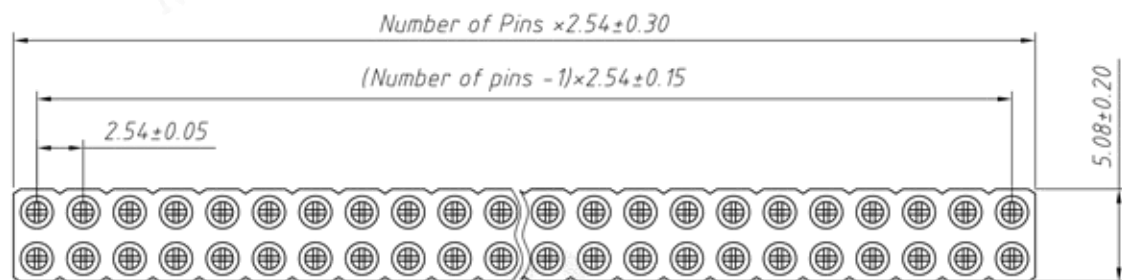
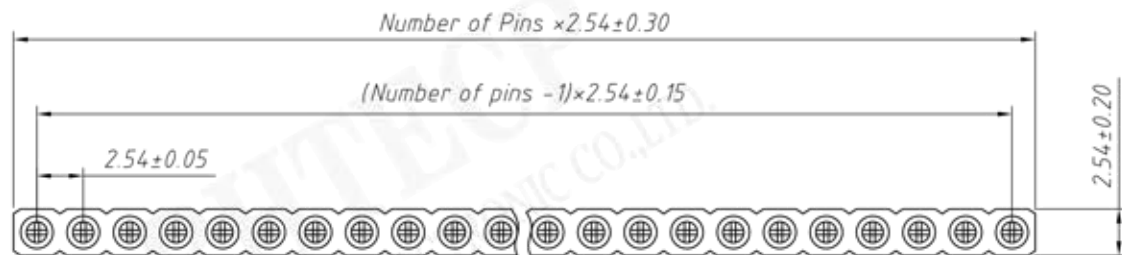

Material:

Housing: 30% Glass filled PPS UL94V-0

Contacts: Beryllium copper or Phosphor Bronze

Plating: Gold 1.25u" over 50u" nickel

Electrical Characteristics:

Current Rating: 3.0 AMP

Insulator Resistance: 1000M Ω min. at DC 100V

Contact Resistance: 10m Ω max.

Operating Temperature: -40°C ~ +105°C

Order Information:

RE-C-209-3.0-1-XX-S-Y

IC Socket

Plastic height:

1.9mm, 3.0mm, 4.2mm, 7.0mm

Row: 1-Single layer

2-Double layer

XX-No. of 02~80pin

Type: S-Straight Pin

R-Right Angle Pin T-SMT Pin

Y-Imported Beryllium copper

Z-Domestic Phosphor Bronze



NINGBO RHT ELECTRONIC CO.,LTD

UNITS: mm

SHEET SIZE: A4

SCALE: ---

RE-C-209-3.0-1-XX-S-Y

>0~3

>3~18

>18~50

>50~120

±0.12

±0.15

±0.3

±0.5

CONNECTORS

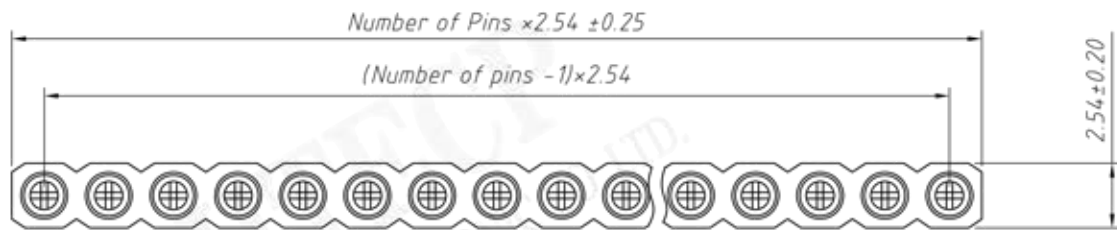

Material:

Housing: 30% Glass filled PPS UL94V-0

Contacts: Beryllium copper or Phosphor Bronze

Plating: Gold 1.25u" over 50u" nickel

Electrical Characteristics:

Current Rating: 3.0 AMP

Insulator Resistance: 1000M Ω min. at DC 100V

Contact Resistance: 10m Ω max.

Operating Temperature: -40°C ~ +105°C

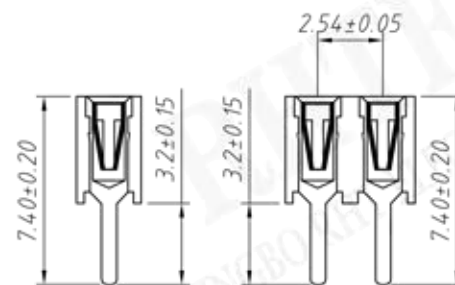
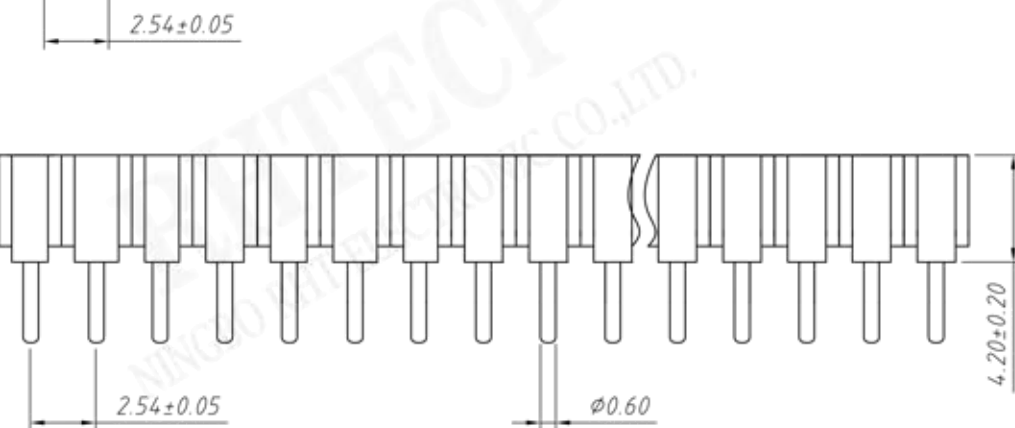
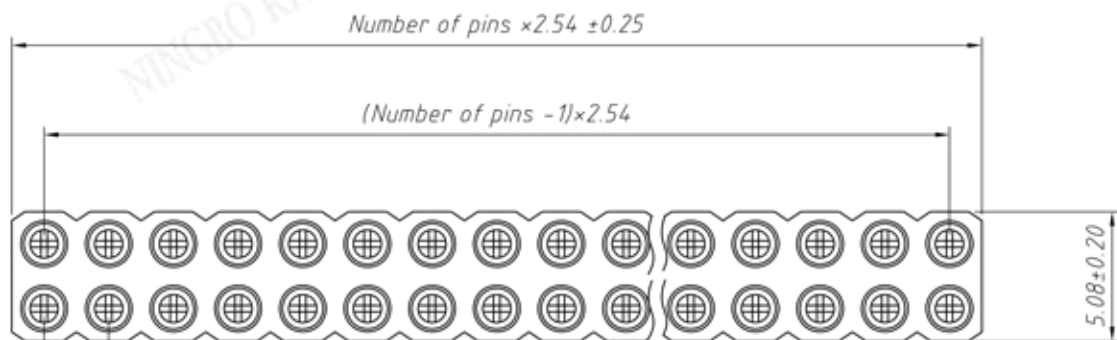

Order Information:

RE-C-209-4.2-1-XX-S-Y

IC Socket

Plastic height:

1.9mm, 3.0mm, 4.2mm, 7.0mm

Row: 1-Single layer

2-Double layer

XX-No. of 02 80pin

Type: S-Straight Pin

R-Right Angle Pin

T-SMT Pin

Y-Imported Beryllium copper

Z-Domestic Phosphor Bronze



NINGBO RHT ELECTRONIC CO.,LTD

UNITS:mm

SHEET SIZE:A4

SCALE:---

RE-C-209-4.2-1-XX-S-Y

>0~3

>3~18

>18~50

>50~120

±0.12

±0.15

±0.3

±0.5

CONNECTORS

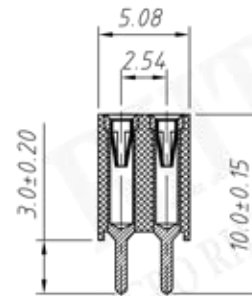
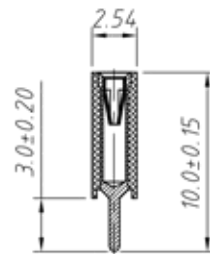
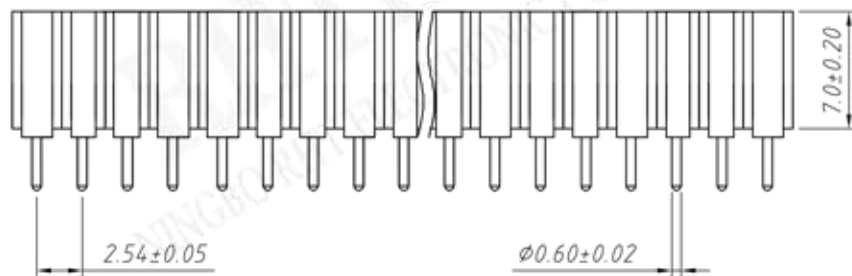
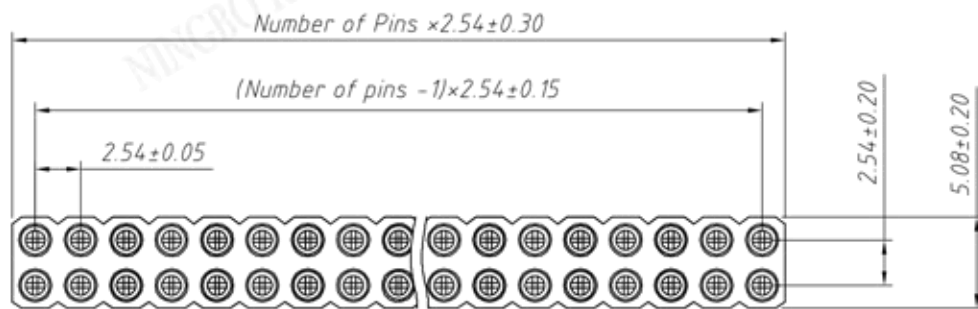
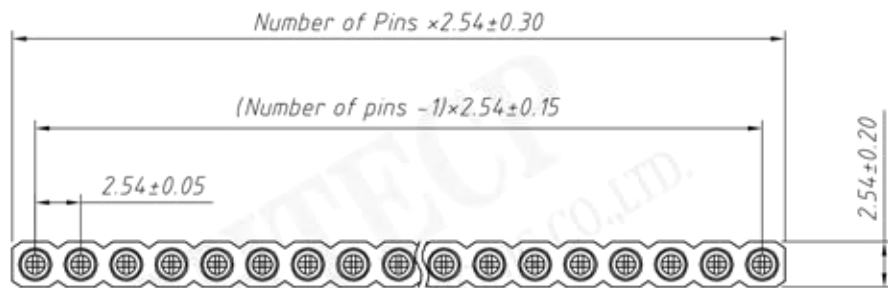

Material:

Housing: 30% Glass filled PPS UL 94V-0
 Contacts: Beryllium copper or Phosphor Bronze
 Plating: Gold 1.25u" over 50u" nickel

Electrical Characteristics:

Current Rating: 3.0 AMP
 Insulator Resistance: 1000MΩ min. at DC 100V
 Contact Resistance: 10mΩ max.
 Operating Temperature: -40°C ~ +105°C

Order Information:

RE-C-209-7.0-1-XX-S-Y

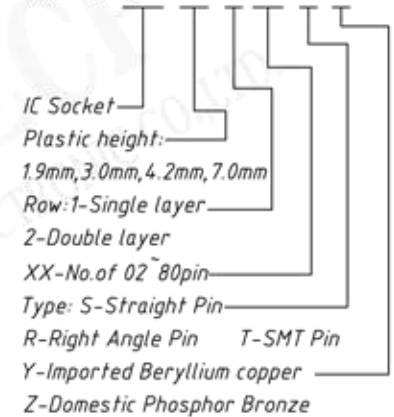

NINGBO RHT ELECTRONIC CO.,LTD

UNITS:mm

SHEET SIZE:A4

SCALE:---

RE-C-209-7.0-1-XX-S-Y

>0~3

>3~18

>18~50

>50~120

±0.12

±0.15

±0.3

±0.5

CONNECTORS

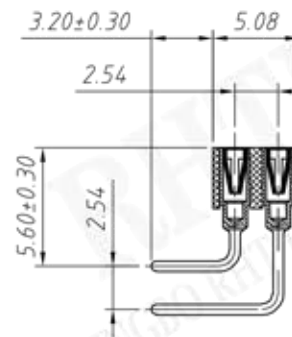
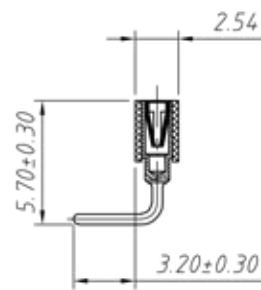
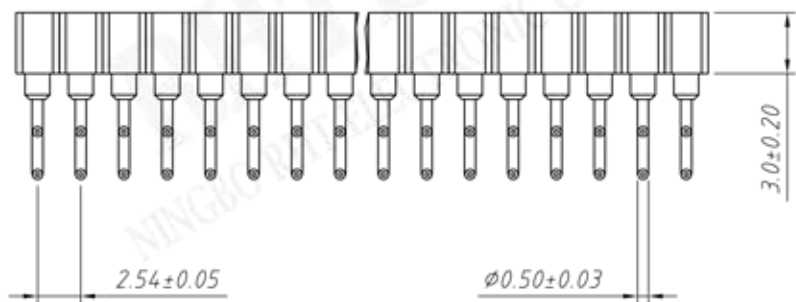
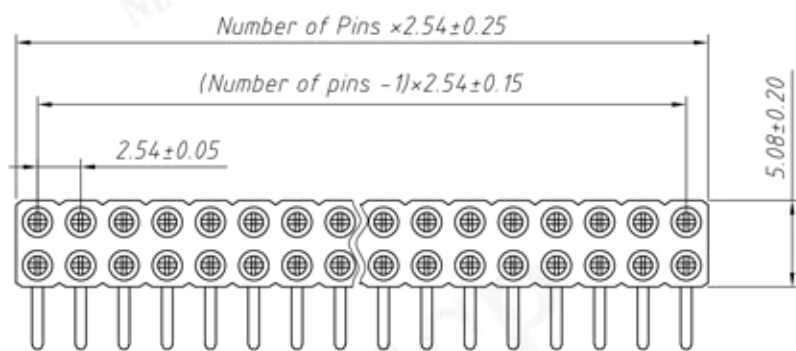
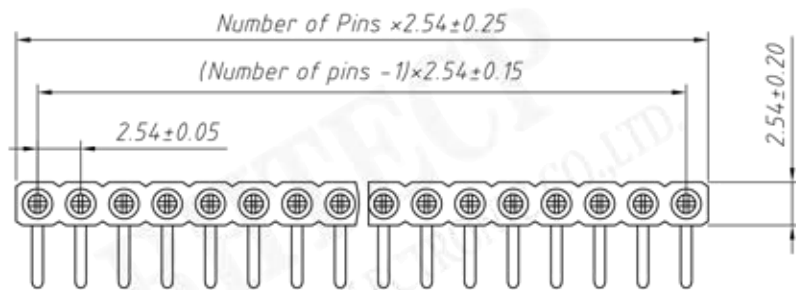

Material:

Housing: 30% Glass filled PPS UL94V-0

Contacts: Beryllium copper or Phosphor Bronze

Plating: Gold 1.25u" over 50u" nickel

Electrical Characteristics:

Current Rating: 3.0 AMP

Insulator Resistance: 1000MΩ min. at DC 100V

Contact Resistance: 10mΩ max.

Operating Temperature: -40°C ~ +105°C

Order Information:

RE-C-209-3.0-1-XX-R-Y

IC Socket

Plastic height:

1.9mm, 3.0mm, 4.2mm, 7.0mm

Row: 1-Single layer

2-Double layer

XX-No. of 02 80pin

Type: S-Straight Pin

R-Right Angle Pin

T-SMT Pin

Y-Imported Beryllium copper

Z-Domestic Phosphor Bronze



NINGBO RHT ELECTRONIC CO.,LTD

UNITS: mm

SHEET SIZE: A4

SCALE: ---

RE-C-209-3.0-1-XX-R-Y

>0~3

>3~18

>18~50

>50~120

±0.12

±0.15

±0.3

±0.5

CONNECTORS

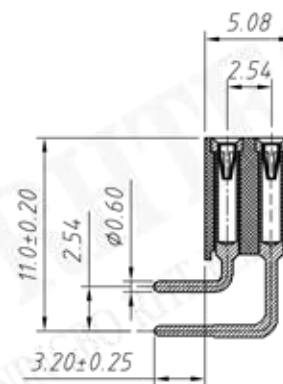
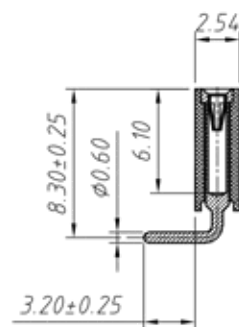
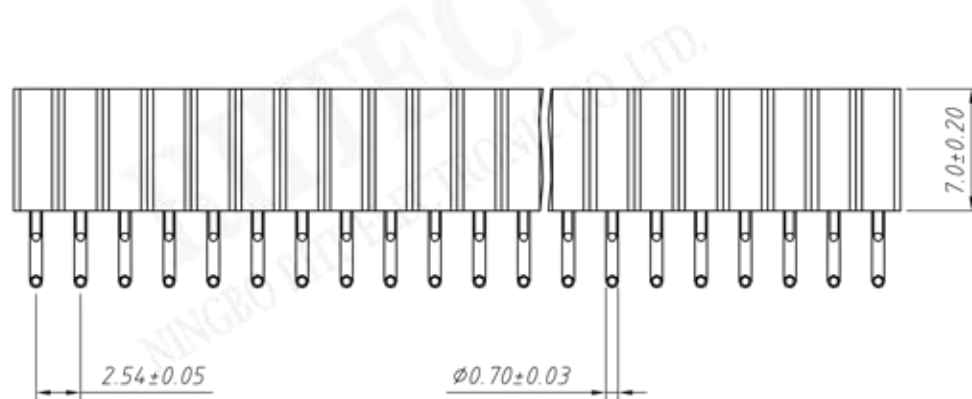
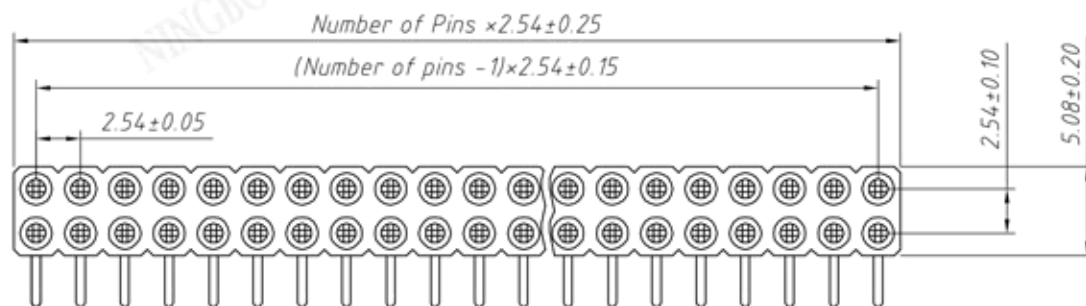
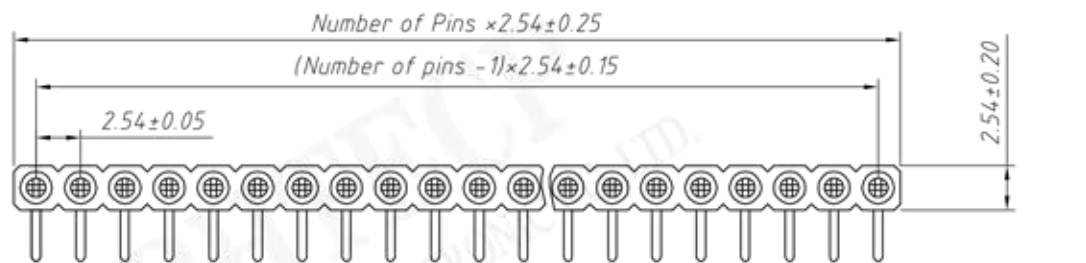

Material:

Housing: 30% Glass filled PPS UL94V-0

Contacts: Beryllium copper or Phosphor Bronze

Plating: Gold 1.25u" over 50u" nickel

Electrical Characteristics:

Current Rating: 3.0 AMP

Insulator Resistance: 1000MΩ min. at DC 100V

Contact Resistance: 10mΩ max.

Operating Temperature: -40°C ~ +105°C

Order Information:

RE-C-209-7.0-1-XX-R-Y

IC Socket

Plastic height:

1.9mm, 3.0mm, 4.2mm, 7.0mm

Row: 1-Single layer

2-Double layer

XX-No. of 02 ~ 80pin

Type: S-Straight Pin

R-Right Angle Pin

Y-Imported Beryllium copper

Z-Domestic Phosphor Bronze

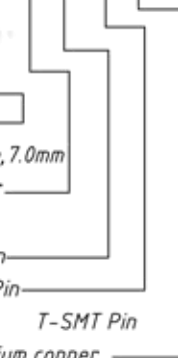

NINGBO RHT ELECTRONIC CO.,LTD

UNITS: mm

SHEET SIZE: A4

SCALE: ---

RE-C-209-7.0-1-XX-R-Y

>0~3

>3~18

>18~50

>50~120

±0.12

±0.15

±0.3

±0.5

CONNECTORS

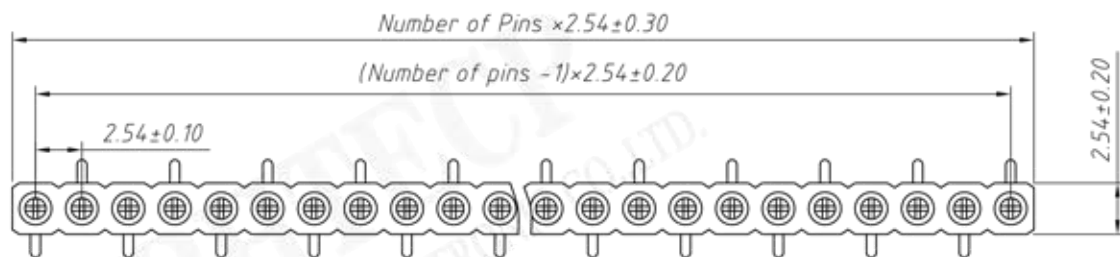

T2 Type

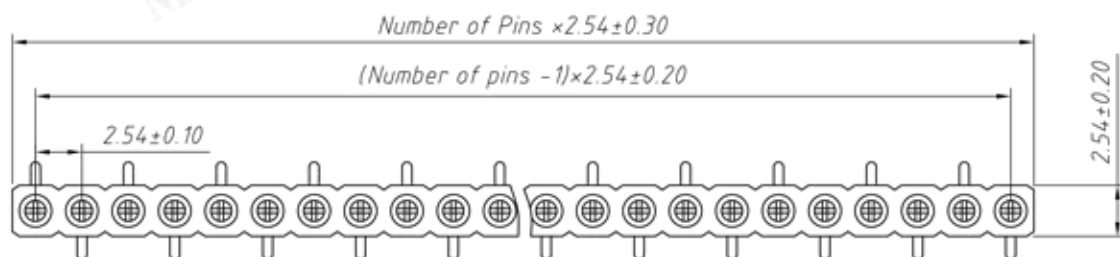

T1 Type

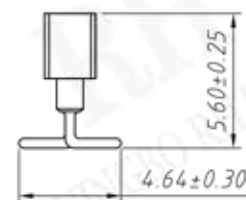
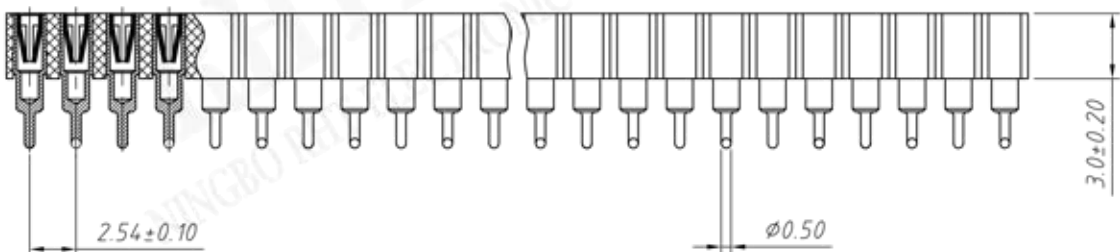

Material:

Housing: 30% Glass filled PPS UL 94V-0

Contacts: Beryllium copper or Phosphor Bronze

Plating: Gold 1.25u" over 50u" nickel

Electrical Characteristics:

Current Rating: 3.0 AMP

Insulator Resistance: 1000MΩ min. at DC 100V

Contact Resistance: 10mΩ max.

Operating Temperature: -40°C ~ +105°C

Order Information:

RE - C - 209 - 3.0 - 1 - XX - T1 - Y

L: RoHS -

IC Socket -

Plastic height: -

1.9mm, 3.0mm, 4.2mm, 7.0mm

Row: 1 - Single layer -

2 - Double layer -

XX - No. of 02~80pin -

SMT Type: T1 Type, T2 Type -

Y - Imported Beryllium copper -

Z - Domestic Phosphor Bronze

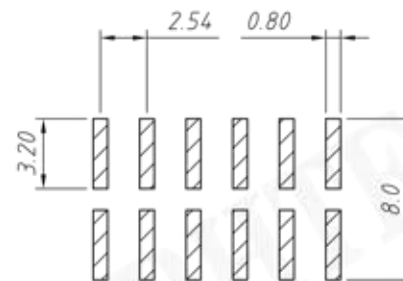
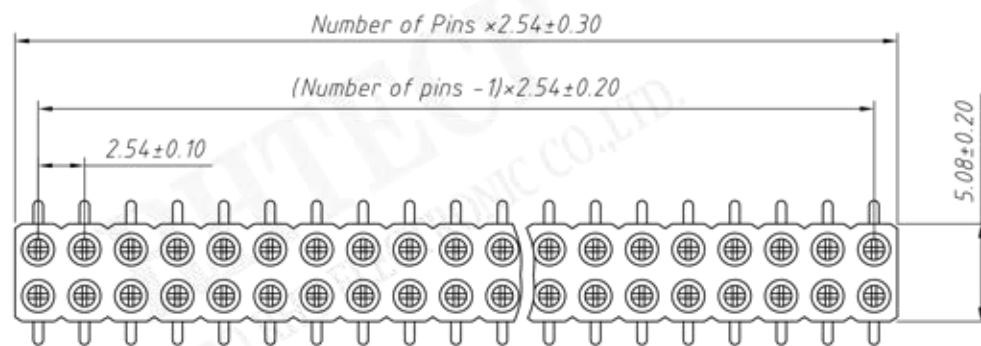

Recommended P.C.B Layout (Top Side)
 (PCB BOARD TOLERANCE ± 0.05)

Material:

Housing: 30% Glass filled PPS UL94V-0
 Contacts: Beryllium copper or Phosphor Bronze
 Plating: Gold 1.25u" over 50u" nickel

Electrical Characteristics:

Current Rating: 3.0 AMP
 Insulator Resistance: 1000M Ω min. at DC 100V
 Contact Resistance: 10m Ω max.
 Operating Temperature: $-40^{\circ}\text{C} \sim +105^{\circ}\text{C}$

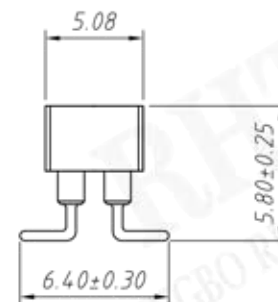
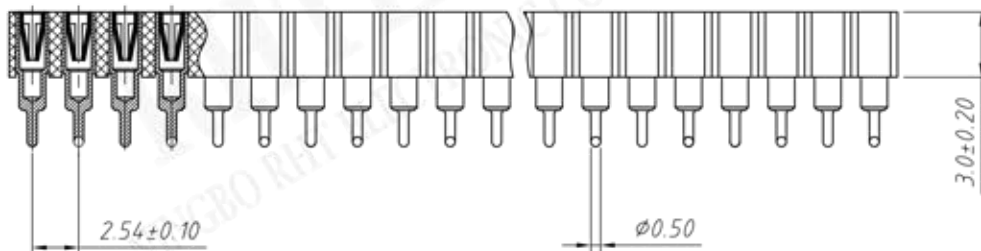

Order Information:

RE-C-209-3.0-2-XX-T-Y

IC Socket
 Plastic height:
 1.9mm, 3.0mm, 4.2mm, 7.0mm
 Row: 1-Single layer
 2-Double layer
 XX-No. of 02~80pin
 Type: S-Straight Pin
 R-Right Angle Pin T-SMT Pin
 Y-Imported Beryllium copper
 Z-Domestic Phosphor Bronze

RHTECP NINGBO RHT ELECTRONIC CO.,LTD

UNITS: mm

SHEET SIZE: A4

SCALE: ---

RE-C-209-3.0-2-XX-T-Y

>0~3

>3~18

>18~50

>50~120

± 0.12

± 0.15

± 0.3

± 0.5

CONNECTORS