

Pin	Dimensions(mm)		Pin	Dimensions(mm)	
	A	B		A	B
02	2.54	5.08	22	53.34	55.88
03	5.08	7.62	23	55.88	58.42
04	7.62	10.16	24	58.42	60.96
05	10.16	12.70	25	60.96	63.50
06	12.70	15.24	26	63.50	66.04
07	15.24	17.78	27	66.04	68.58
08	17.78	20.32	28	68.58	71.12
09	20.32	22.86	29	71.12	73.66
10	22.86	25.40	30	73.66	76.20
11	25.40	27.94	31	76.20	78.74
12	27.94	30.48	32	78.74	81.28
13	30.48	32.02	33	81.28	83.82
14	32.02	35.56	34	83.82	86.36
15	35.56	38.10	35	86.36	88.90
16	38.10	40.64	36	88.90	91.44
17	40.64	43.18	37	91.44	93.98
18	43.18	45.72	38	93.98	96.82
19	45.72	48.26	39	96.82	99.06
20	48.26	50.80	40	99.06	101.60
21	50.80	53.34			

Material:
Housing: PPO, UL 94V-0, Black

Electrical Characteristics:
Rated Current: 3.0AMP
Voltage rating: 250V AC, DC
Temperature range: -25°C ~ +85°C
Insulator Resistance: 1000MΩ Min
Withstanding Voltage: 1500V AC/minute
Contact Resistance: 20mΩ Max

Order Information:

RE - C - 540A - 1×XX - H

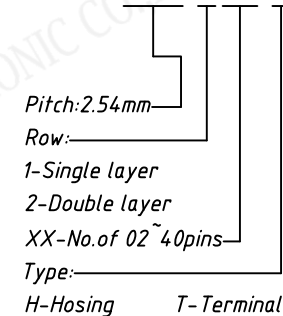

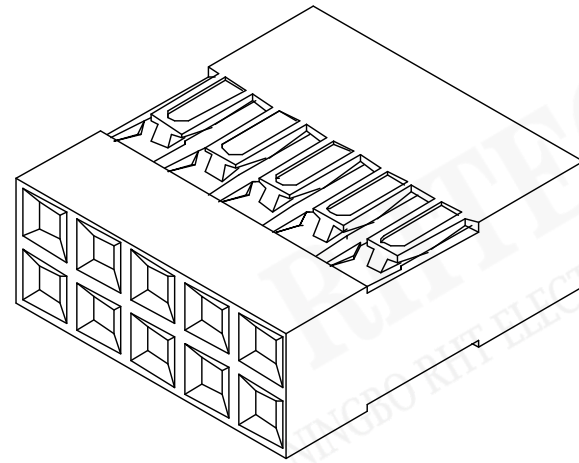
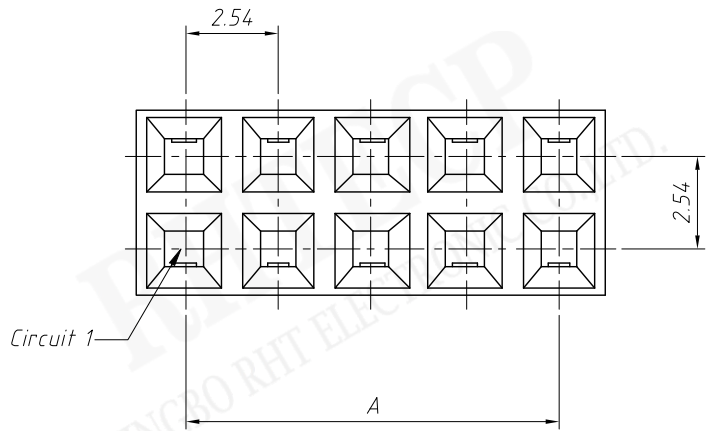

Pin	Dimensions(mm)		Pin	Dimensions(mm)	
	A	B		A	B
02	2.54	5.08	22	53.34	55.88
03	5.08	7.62	23	55.88	58.42
04	7.62	10.16	24	58.42	60.96
05	10.16	12.70	25	60.96	63.50
06	12.70	15.24	26	63.50	66.04
07	15.24	17.78	27	66.04	68.58
08	17.78	20.32	28	68.58	71.12
09	20.32	22.86	29	71.12	73.66
10	22.86	25.40	30	73.66	76.20
11	25.40	27.94	31	76.20	78.74
12	27.94	30.48	32	78.74	81.28
13	30.48	32.02	33	81.28	83.82
14	32.02	35.56	34	83.82	86.36
15	35.56	38.10	35	86.36	88.90
16	38.10	40.64	36	88.90	91.44
17	40.64	43.18	37	91.44	93.98
18	43.18	45.72	38	93.98	96.82
19	45.72	48.26	39	96.82	99.06
20	48.26	50.80	40	99.06	101.60
21	50.80	53.34			

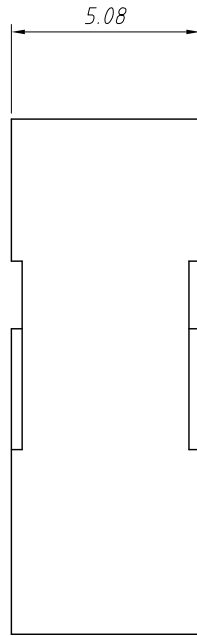
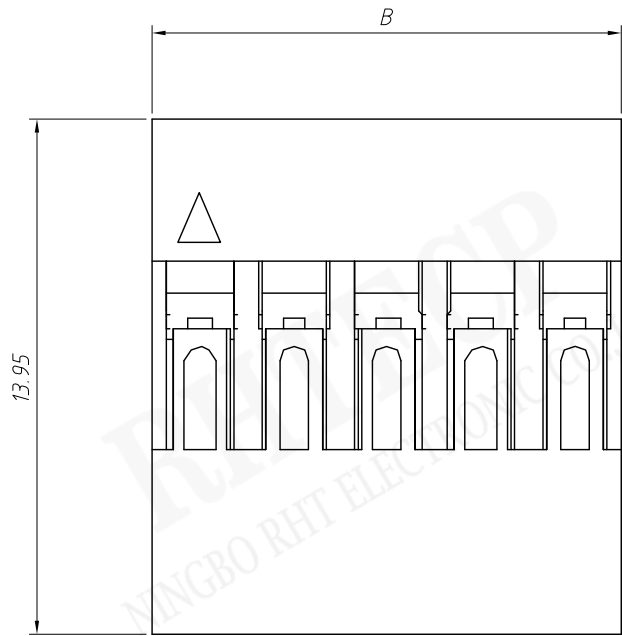

Material:
Housing:PPO,UL 94 V-0,Black

Electrical Characteristics:
Rated Current:3.0AMP
Voltage rating:250V AC,DC
Temperature range:-25°C ~ + 85°C
Insulator Resistance:1000M Ω Min
Withstanding Voltage:1500V AC/minute
Contact Resistance:20m Ω Max

Order Information:

RE-C-540A-2 \times XX-H

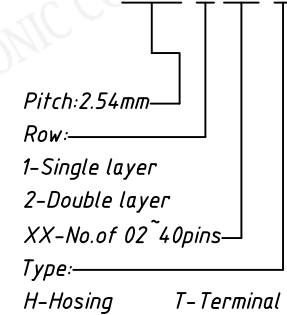

RHTECP NINGBO RHT ELECTRONIC CO.,LTD

UNITS:mm

SHEET SIZE:A4

SCALE:---

RE-C-540A-2 \times XX-H

0~3

3~18

18~50

50~120

± 0.12

± 0.15

± 0.3

± 0.5

CONNECTORS

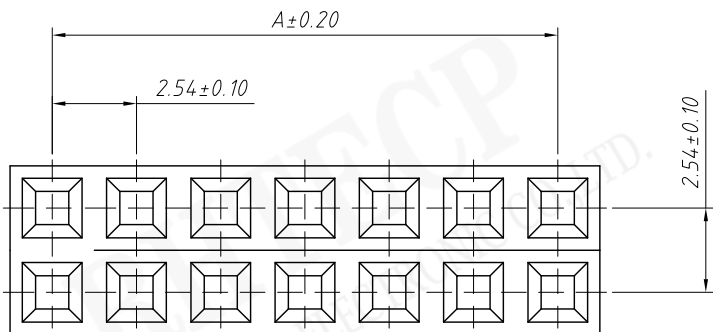

Material:
Housing:PBT,UL 94V-0

Electrical Characteristics:
Rated Current:3.0AMP
Voltage rating:250V AC,DC
Temperature range:-25°C ~ + 85°C
Insulator Resistance:1000MΩ Min
Withstanding Voltage:1500V AC/minute
Contact Resistance:20mΩ Max

Pin	Dimensions(mm)		Pin	Dimensions(mm)	
	A	B		A	B
02	2.54	5.08	22	53.34	55.88
03	5.08	7.62	23	55.88	58.42
04	7.62	10.16	24	58.42	60.96
05	10.16	12.70	25	60.96	63.50
06	12.70	15.24	26	63.50	66.04
07	15.24	17.78	27	66.04	68.58
08	17.78	20.32	28	68.58	71.12
09	20.32	22.86	29	71.12	73.66
10	22.86	25.40	30	73.66	76.20
11	25.40	27.94	31	76.20	78.74
12	27.94	30.48	32	78.74	81.28
13	30.48	32.02	33	81.28	83.82
14	32.02	35.56	34	83.82	86.36
15	35.56	38.10	35	86.36	88.90
16	38.10	40.64	36	88.90	91.44
17	40.64	43.18	37	91.44	93.98
18	43.18	45.72	38	93.98	96.82
19	45.72	48.26	39	96.82	99.06
20	48.26	50.80	40	99.06	101.60
21	50.80	53.34			

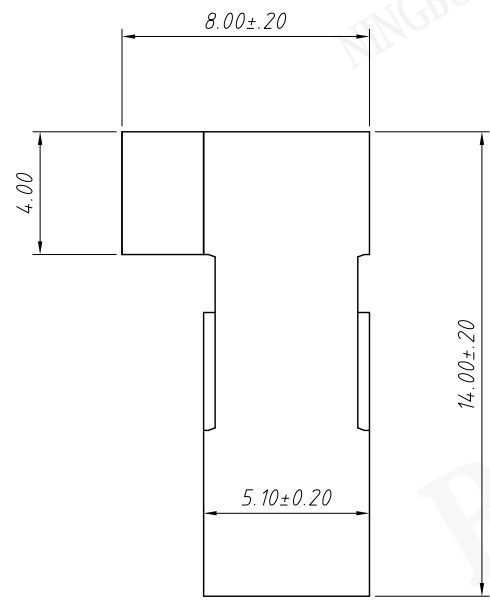
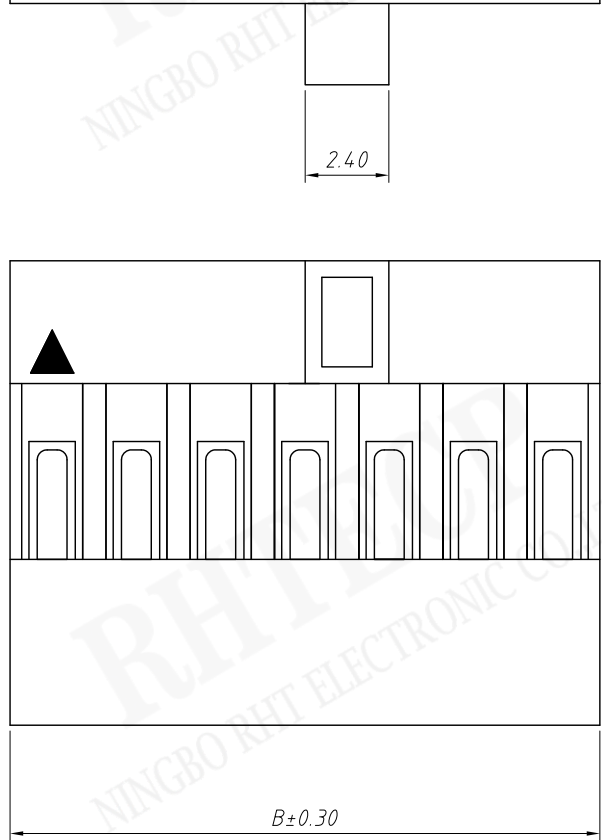

Order Information:
RE - C - 540AB - 2×XX - H

Pitch:2.54mm
Row:
1-Single layer
2-Double layer
XX-No. of 02~40pins
Type:
H-Hosing T-Terminal

UNITS:mm	SHEET SIZE:A4		SCALE:---
0~3	3~18	18~50	50~120
±0.12	±0.15	±0.3	±0.5

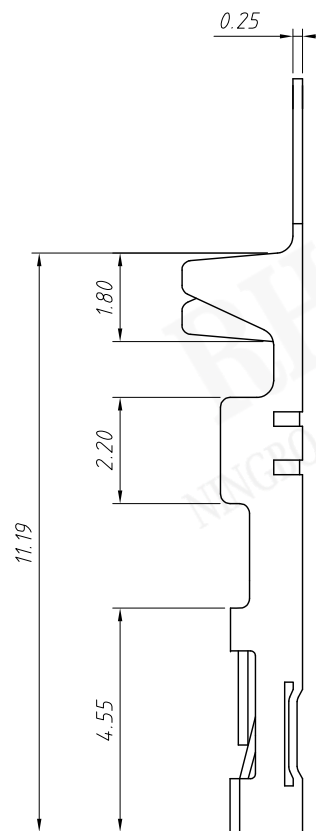
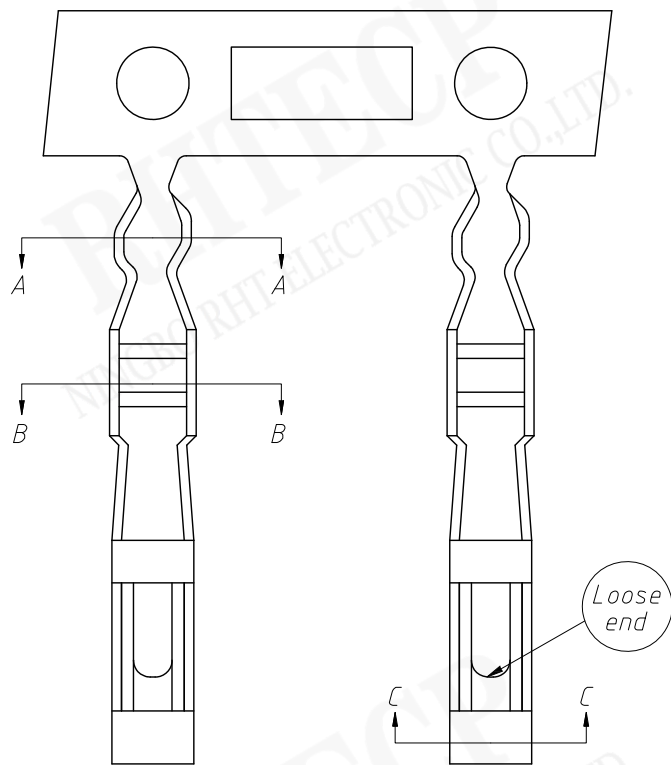

Material:
 Terminal: Phosphor Bronze / Brass
 Plating: Tin plated over Gold-Flash
 Applicable wires: AWG #22~# 26
 Insulation O.D: 1.63mm
 Qty/reel: 10000 pcs

Electrical Characteristics:
 Rated Current: 3.0AMP
 Voltage rating: 250V AC,DC
 Temperature range: -25°C ~ + 85°C
 Insulator Resistance: 1000MΩ Min
 Withstanding Voltage: 1500V AC/minute
 Contact Resistance: 20mΩ Max

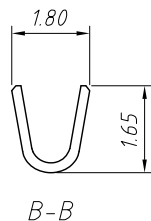
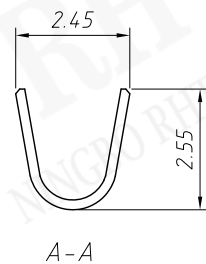
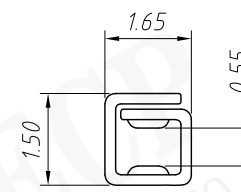

Order Information:
 RE-C-540A-T
 Pitch: 2.54mm
 Type:
 H-Hosing T-Terminal



NINGBO RHT ELECTRONIC CO.,LTD

UNITS:mm

SHEET SIZE:A4

SCALE:---

0~3

3~18

18~50

50~120

±0.12

±0.15

±0.3

±0.5

RE-C-540A-T

CONNECTORS